

# APO-DIGITAR 4/60

H

$f' = 59.9 \text{ mm}$      $\beta_p = 0.970$   
 $s_F = -47.1 \text{ mm}$      $s_{EP} = 14.6 \text{ mm}$   
 $s_{F'} = 40.8 \text{ mm}$      $s_{AP} = -17.3 \text{ mm}$   
 $HH' = -1.9 \text{ mm}$      $\Sigma d = 30.0 \text{ mm}$

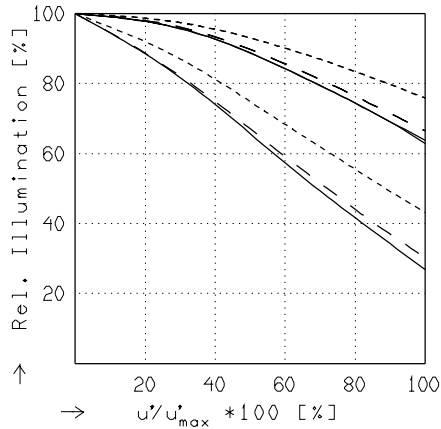
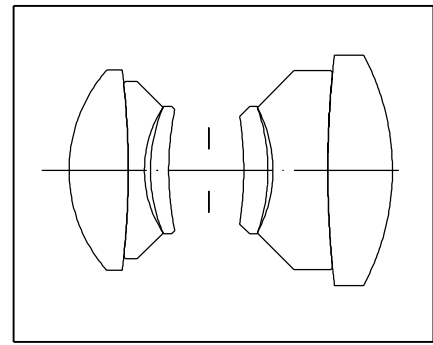

## RELATIVE ILLUMINATION

The relative illumination is shown for the given focal distances or magnifications.

$f / 4.0$        $f / 8.0$        $f / 11.0$

—  $\beta' = -0.0500$      $u'_{max} = 30.1$      $00' = 1319.$   
 - -  $\beta' = -0.1000$      $u'_{max} = 30.1$      $00' = 723.$   
 - · -  $\beta' = -0.3333$      $u'_{max} = 30.0$      $00' = 318.$

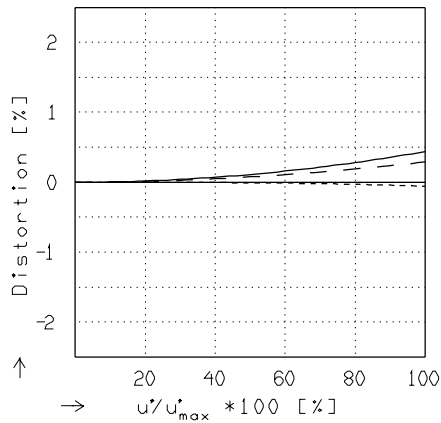

## DISTORTION

Distortion is shown for the given focal distances or magnifications. Positive values indicate pincushion distortion and negative values barrel distortion.

—  $\beta' = -0.0500$      $u'_{max} = 30.0$      $00' = 1319.$   
 - -  $\beta' = -0.1000$      $u'_{max} = 30.0$      $00' = 723.$   
 - · -  $\beta' = -0.3333$      $u'_{max} = 30.0$      $00' = 318.$

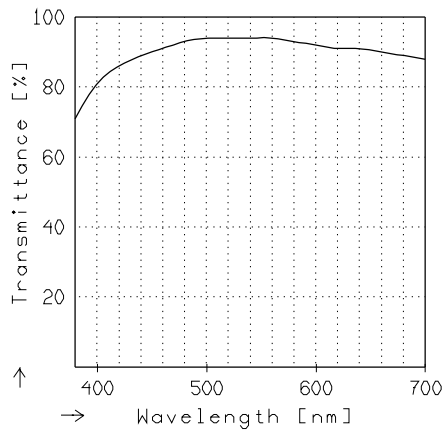

## TRANSMITTANCE

Relative spectral transmittance is shown with reference to wavelength.

**APO-DIGITAR 4/60**

**H**

**MODULATION** with reference to the relative image height

Wavelength  $\lambda$  [nm] : 520 670 620 570 470 420  
 Spectral weighting [%] : 19.0 10.0 19.0 19.0 19.0 14.0  
 Spatial frequency R [1/mm] : 20 40 60  
 Format [mm X mm] : 30.0 X 30.0  
 Diagonal  $2u'$  [mm] : 60.0

radial —  
 tangential - -

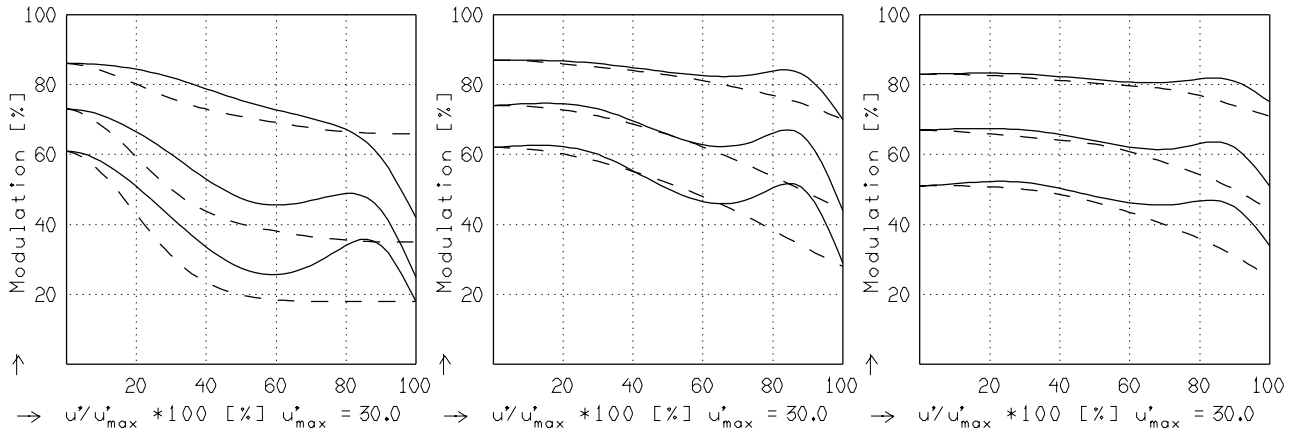

$f^* = 59.9$   $f / 4.0$   $1/\beta^* = -20.00$   $00^* = 1319.$     $f^* = 59.9$   $f / 8.0$   $1/\beta^* = -20.00$   $00^* = 1319.$     $f^* = 59.9$   $f / 11.0$   $1/\beta^* = -20.00$   $00^* = 1319.$

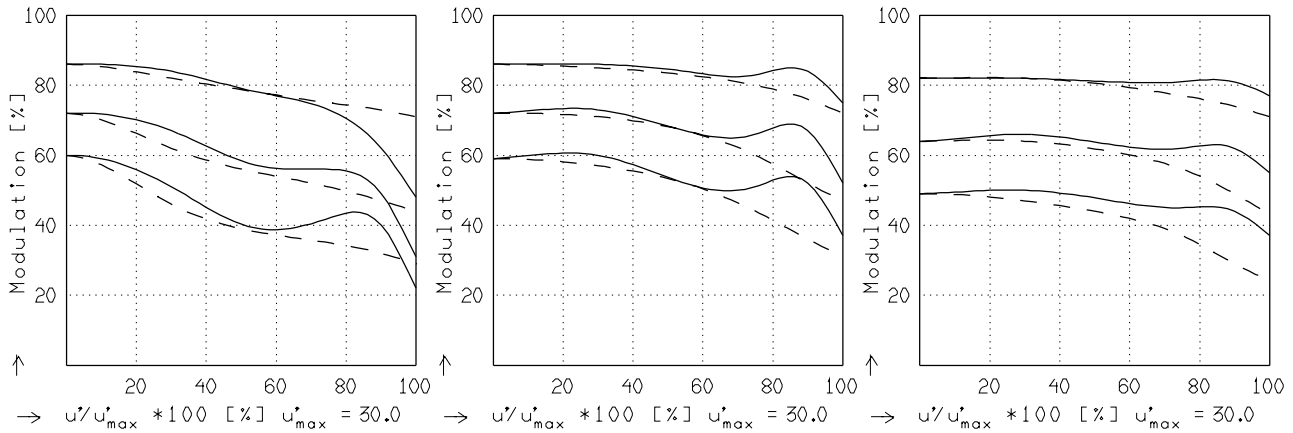

$f^* = 59.9$   $f / 4.0$   $1/\beta^* = -10.00$   $00^* = 723.$     $f^* = 59.9$   $f / 8.0$   $1/\beta^* = -10.00$   $00^* = 723.$     $f^* = 59.9$   $f / 11.0$   $1/\beta^* = -10.00$   $00^* = 723.$

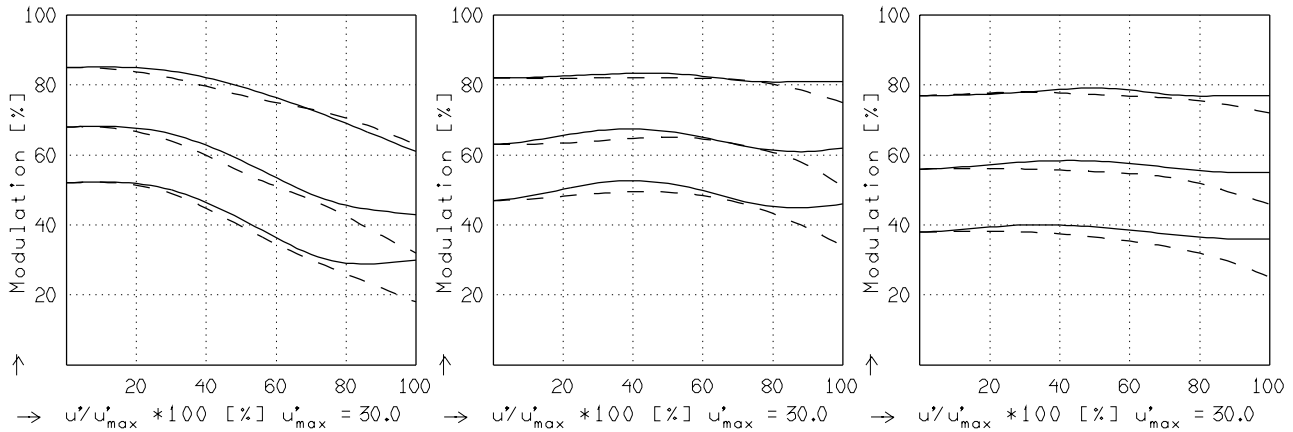

$f^* = 59.9$   $f / 4.0$   $1/\beta^* = -3.00$   $00^* = 318.$     $f^* = 59.9$   $f / 8.0$   $1/\beta^* = -3.00$   $00^* = 318.$     $f^* = 59.9$   $f / 11.0$   $1/\beta^* = -3.00$   $00^* = 318.$

Focusing :  $MTF_{max}$  at  $f / 4.0$  ,  $R = 60$  1/mm,  $u'/u'_{max} = 0$

45780 91101 Printed in the Federal Republic of Germany